

# User manual

PT Network Camera

SD3680/SD3722

## CONTENTS

Product Assurance .....	3
Approval Information.....	4
Infrared Night Vision.....	9
Installation.....	10
Connecting the cameras .....	10
Camera Search tool Installation & Usage.....	10
Review Images from the Network CAMERA.....	16
Introduction of Main page .....	18
System Setting.....	20
System status.....	21
Network .....	21
Local network .....	21
PPPOE Account Configure .....	23
Wireless Network.....	23
DDNS Settings.....	25
UPnP .....	26
Camera Settings .....	27
Stream Setup .....	28
Night Vision Settings .....	30
Multi Device settings .....	30
Alarm Settings.....	32
Motion Detection settings.....	32
Port Alarm .....	32
Alarm Management.....	33
Periodic Record Schedule.....	34
Periodic sending .....	34
File Store.....	34
SMTP.....	35
FTP .....	36
System Management .....	37
Hostname .....	37
User Management .....	37
Time Settings .....	38
Disk Management.....	39
Disk Management.....	39
Restore.....	40
Firmware Update .....	40
Specification .....	41
FAQ.....	42

# INTRODUCTION

Thank you for your interest and support in our product and purchasing this 3GPP network camera. The camera can be accessed remotely, and controlled from any PC/laptop over the Intranet or Internet via web browser. The user-friendly installation procedure and intuitive web-based interface offer easy integration with your LAN environment or WiFi system. The camera also comes with a lot of useful alarm tool for notice user any situation. We feel confident that you will be pleased with the quality and features of this product.

## Notice

This product may cause interferences with other wireless equipment that operates at 2.4GHz ISM band. Please turn off one of the equipments to eliminate the interference.

## Product Assurance

This camera will emit electromagnetic wave, just like other wireless products, but its transmitting power is less than other wireless products such as mobile phones. The 2.4GHz wireless camera meets wireless frequency security standards and recommended indexes while working. These standards and indexes are certificated by academic organization and represent the cogitative research of the scientific workers who continuously explore and annotate the involved fields. So we believe that our products are safe for customers

## Approval Information

All our products meet the requirements of approval FCC or CE, and are granted the FCC or CE certification. They are authorized to bear FCC or CE mark.

### FCC

This equipment has been tested and found to comply with the limits for a Class B digital device, pursuant to Part 15 of the FCC rules. These limits are designed to provide reasonable protection against harmful interference in a residential installation. This equipment generates and radiates radio frequency energy and, if not installed and used in accordance with the instructions, may cause harmful interference to radio communications. However, there is no guarantee that interference will not occur in a particular installation. If this equipment does cause harmful interference to radio or television reception, which can be determined by turning the equipment off and on, the user is encouraged to try to correct the interference by one or more of the following measures:

1. Reorient or relocate the receiving antenna
2. Increase the separation between the equipment and the receiver
3. Connect the equipment into an outlet on a circuit different from that to which the receiver is connected
4. Consult the dealer or an experienced radio/TV technician for help

This device complies with Part 15 of the FCC Rules. Operation is subject to the following two conditions:

- (1) The device may not cause harmful interference and
- (2) This device must accept any interference received, including interference that may cause undesired operation changes and modification not expressly approved by the manufacturer or registrant of this equipment can void your authority to operate this equipment under Federal Communications Commission rules.

### CE

This product complies with standards including low voltage device directive 73/23/EEC, EMC directive 89/336/EEC and R&TTE directive 1999/5/EC. It passed the subject tests by the authority concerned and is authorized to bear CE mark.

### Restrictions

1. Do NOT use this product to violate one's privacy. Monitoring one's activities without consent is illegal and this product is not designed and manufactured for such purpose.
2. DO NOT put this product near any medical equipment. Radio waves might potentially cause breakdown of electrical medical equipment.
3. This product should be placed at least 1 foot away from any heart pacemaker. Radio waves might potentially influence heart pacemaker
4. DO NOT use this product for any illegal activities. It is the user's responsibility to ensure that the usage of this camera is of a legal nature

---

## **Maintenance**

1. Ensure that the camera and its power source have sufficient ventilation
2. Do not shake strike or drop the product
3. Keep the camera dry and dustless
  
4. Do not place the product near any magnetic objects
5. Avoid putting the product in places where there is constant temperature and humidity change
6. Keep the product away from heat sources
7. Do not use the camera near aggressive chemicals
8. Do not use the camera near to water
9. Do not use the camera in the places which are enclosed by metal The surrounding metal may shield the electromagnetic waves, and result in failure of the signal reception
10. Please obey the local government's environment protection policy
11. Please turn off the power when left unused
12. Do not disassemble or attempt to repair the camera, doing so might cause damage to the product

# MAIN FEATURES

## Easy Installation

The camera comes with built-in wireless (IEEE802.11B/G) capability and a web server, therefore there is no need to install a driver. The setup CD-ROM includes the camera setup software, user manual and quick installation guide

With industry standard automatic configuration-UPNP (Universal Plug and Play), your PC will discover and connect to your camera automatically. Once connected, using a simple web browser you can see what the camera sees from anywhere in the world!

The camera can be either wall-mounted or ceiling-mounted using the supplied stand. It can also be placed on a desktop using the supplied stand, thus providing a flexible installation solution.

### Quick Installation Guide

Connect Camera to the network	Connect DC Power(Wait for Power light to go green) Connect Ethernet cable from camera to the broadband router
Run Camera Search to find Camera on your network	Run CD "autorun.exe" to install software on a PC connected to the network Select "Tools" from the menu Select "Camera Search" (runs CTVS camera search Installer) Run Camera Search Program(from the Windows desktop) Click "Begin Search" (may need to be repeated several times until the camera is found) Select the installed camera (high in blue) Click "Open device" and browser window to the camera will open
Configure browser to access camera	Install Active X (may need to change your browser security settings to allow Active X control to be installed and enabled) Enter user name(admin) and password(admin) Browser window should now display the camera video window and a left hand control panel
Configure Camera with network & user settings	Click "System Setup" and configure required network settings for wireless access, remote access from the internet and mobile phones and setting email alerts
Configuring Wireless Network Access	Go to Menu: System Setup—Network—Wifi Click "Scanning" Select the wireless network you wish to use Enter encryption and password settings(refer to your wireless broadband router user guide) Click "Apply" the camera will reset and the Ethernet cable must be disconnected. When the camera restarts, you should be able to see the camera

	<p>video in the browser window. If not, then recheck your wireless network settings.</p>
<p>Viewing the Camera remotely with UPnP</p>	<p>Go to Menu: System Setup—Network—UPnP</p> <p>If your router supports UPnP then Enable UPnP Port forwarding which allows camera to open ports on the router automatically so that the video streams can be sent out from your internal network.</p> <p>Get the IP and port settings from “system setup –system status –UPnP—Internet address</p> <p>To access the camera remotely type <a href="http://ipaddress:httpPort/">http://ipaddress:httpPort/</a> in your browser window.</p>
<p>Viewing the Camera remotely using DDNS</p>	<p>Go to Menu: System Setup—Status</p> <p>Note the local IP Address, http port and control Port and External IP Address, http port and control Port.</p> <p>If your router doesn't support UPnP, you will get an IP address for the camera that can be accessed from the internet.</p> <p>You must register with a free dynamic DNS service such as DynDNS (<a href="http://www.dyndns.com">http://www.dyndns.com</a>). They will assign an external hostname that is linked to your external Hostname that is linked to your internal IP address which you can use to access your camera from the internet.</p> <p>You must first “port forward” the camera Local web port and Local sever port for the camera Local IP address in your router configuration(refer to your router documentation).</p> <p>To access the camera remotely type.</p> <p><a href="http://hostname.dyndns.org:http_web_port">http://hostname.dyndns.org:http_web_port</a> in your browser window.</p>
<p>Viewing the camera remotely on a mobile phone via RTSP over a mobile phone network or via a wifi connection</p>	<p>Go to Menu: System Setup—Status</p> <p>Note the internet IP address, rstp Port and extension name. To access the camera remotely from your phone type <a href="rtsp://ipaddress:rtspport/main.mp4">rtsp://ipaddress:rtspport/main.mp4</a> in your browser window Or...</p> <p>Go to Menu: System Setup—Stream Settings—Stream list</p> <p>Note the Internet IP Address, rstp port and extension time. To access the camera remotely from your phone type <a href="rtsp://ipaddress:rtspport/mobile">rtsp://ipaddress:rtspport/mobile</a> in your browser window</p> <p>A streaming application such as RealPlayer will load and play the video stream on your phone.</p> <p>Note: some mobile operators block rtsp video streaming. In the case you may only be able to view the camera video stream on your mobile phone using a WIFI connection.</p>

### 802.11b/g Wireless LAN Connection Available

The camera is designed to not only work with your existing wired network but also with standard 802.11b/g wireless devices, allowing the flexibility to operate the camera wirelessly. The camera utilizes SSID filtering. Powerful 64/128 bit WEP and new security standard WPA encryption to protect you from illegal instruction.

---

### **3GPP Mobile Surveillance**

The camera provide the ability to view the cameras monitored through your mobile phone as a live video stream, it supports the telecommunications standard of 3GPP streaming format. All 3G Enable mobile devices and most 2G phones that support the streaming standard of 3GPP are compatible.

### **Simultaneous High-speed MPEG-4 and Motion JPEG**

The camera allows live the MPEG-4 and Motion JPEG streams simultaneously. The camera features MPEG-4 compression which compresses the video to make transmission faster and more efficient. The MPEG-4 and MJPEG image can be transmitted at 30frames per second.

### **Simultaneous HTTP and RTSP streaming**

The camera support HTTP and RTSP/RTP/RTCP protocol, and provide multiple HTTP and RTSP streams simultaneously

### **Audio Transmission**

The camera comes with a built-in microphone for audio monitoring as well as video monitoring .Sound captured by the camera is transmitted to the client's PC

### **Snapshot and Recording**

You can capture a still image of the camera view on your PC and save the image as JPG or BMP format file. You also can record the video and audio captured by the camera on your PC and save as an ASF format file.

### **Motion Detection Function**

The camera can detect changes in the image being monitored .Once a change occurs it will send an email to up to 3email address with a video file or snapshot attached .The video file or snapshot can also be uploaded to an FTP server .In addition the camera can be configured to send images at regular intervals.

### **OSD Function**

OSD (On Screen Display) function can display system name, date and time and user-defined on screen

### **Authentication**

An authentication window requires you to enter the user ID and password .Password security can prevent unregistered users from accessing your camera .Users can select Basic Authentication Method or Digest Access Authentication method.

### **Multi-Client Access**

The camera allows up to 6users to view simultaneously .Please note that this is possible that as the number of simultaneously connected users to camera increases ,the overall motion performance will decrease.

---

## Infrared Night Vision

The camera utilizes 30infrared LED to provide high in dark environment. When the environment is dark, the LED will be opened automatically due to a photosensitive component, and the moving images will be changed to Black and White. User can monitor clearly the things within 15meters distance. Users also can select open or close the infrared LED manually, and select whether change the image to black and white or color automatically.

## Adapter

The product conforms with the authenticated AC adapter .The adapter is marked with one or more of the following.



### Notice:

When using the power adapter, make sure the rating voltage on it is compatible with that of the device to avoid potential damages resulting from incorrect usage of power supply .

## PC System Requirements

The PC(personal Computer )and the network must meet the following technical specifications for camera to work properly

1. Processor: Intel Pentium III, 1GHZ or Higher (Pentium IV, 2GHZ or Higher recommended)
2. RAM: 256MB or more
3. Color Monitor: Suggest at least 800x600 and the latest driver for the Display Adapter
4. OS (Operating System):Windows2000/XP/Vista
5. Web Browser: Internet Explorer version 5.0 or above, DirectX 9.0C or later
6. Network Protocol: TCP/IP network protocol installed
7. Interface: 10/100 Mbps Ethernet card/wireless Network card for your network connection
8. Other: CD-ROM Drive

---

# Installation

## Connecting the cameras

Using a standard Ethernet network cable, connect the camera to your network (depending on your own setup, this may be to your router or switch). See figure below

Connecting the adaptor with power, camera will detect automatically, and the “power” status LED will blinks. Then, Network camera will be ready to start.

### Rear view of camera

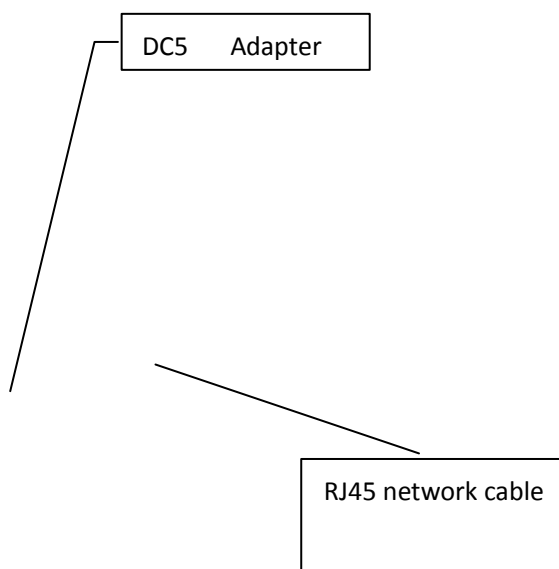

**Notice:** Please be careful when connect the adapter to socket

## Camera Search tool Installation & Usage

Camera Search tool can connect quickly to your cameras in LAN and set out them in the window. Meanwhile, you can set up the IP address to every camera in this software.

1. Insert the Installation CD into your CD-ROM drive and the installation screen should appear automatically (See image below). If not, click “[autorun.exe](#)” in the text.

---

2. Click on “Install Software” and the following screen will be displayed. And click “Next” and install:



3. If you want to change the default files, click “browse”, otherwise click “next”.

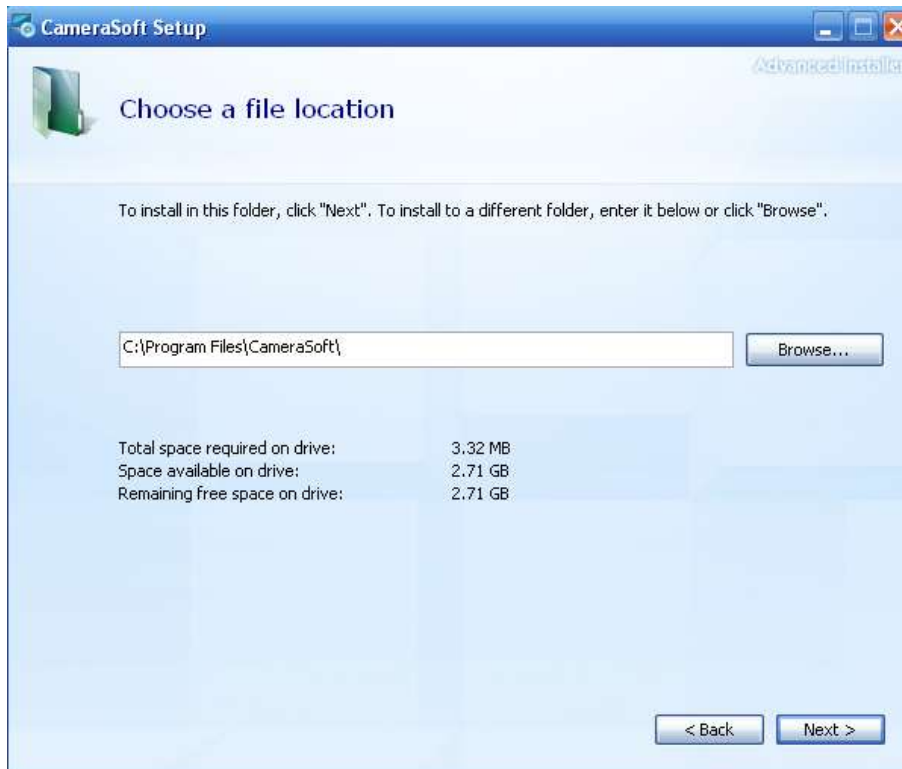

4. Click “install”

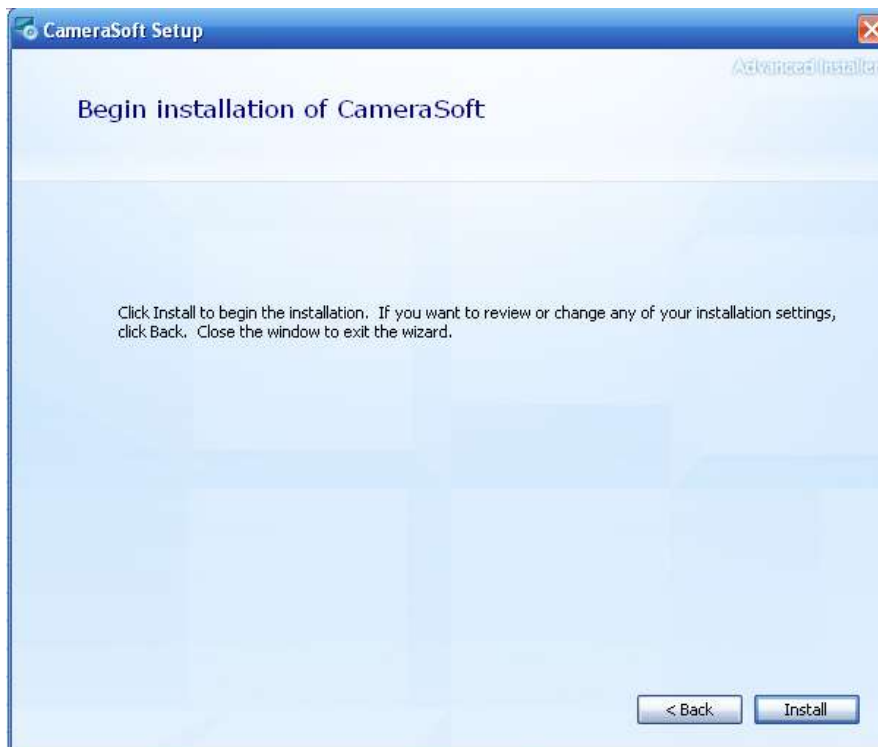

5. Click **Finish** to end the installation



【Search】 : Click **Search** to search the cameras in LAN

【Setup】 : Select the required camera and click **Set up** the network configuration

【Open】 : Select the required camera and click **Open** to access the camera via a web browser

【Exit】 :Click **Exit** to exit the Camera Setup window



**Notice:** Select and double click to open the camera view via the web browser.

### Run the “Camera Search” program to locate the newly installed network cameras



**Notice:** If there is no DHCP server, Network Cameras display the factory default IP address in the search software, factory default IP address: 192.168.1.239. When there are DHCP server in the LAN, MINI Series Network Camera will obtain IP address automatically from the DHCP server and display in the device list with the LAN IP address. Please make sure that IP address of net work camera is different from other devices’.

1. Run the “**Camera Search**”, program will search cameras in LAN automatically
2. Select one of the IP from the device list (the selected one show with blue), click on the "set up" button, the following screen will be displayed.

3. 【Name】 : Enter a unique name for the camera 【Description】 : Input description, such as location of camera 【Http Port】 : Default is 80.

“Obtain IP address automatically” and “obtain DNS server address automatically” are default, and also you can choose “Use the following IP address” to set up by yourself. Please follow the step 4 to 7. If you need to save default setting, you can see next page directly.

4. To obtain the IP addresses specific to your network, click “Start”—“Run”, then type “cmd”. A

window of MS-DOS will be displayed, and then type “**ipconfig/all**”—press **Enter**, a screen similar to the one below will be displayed.

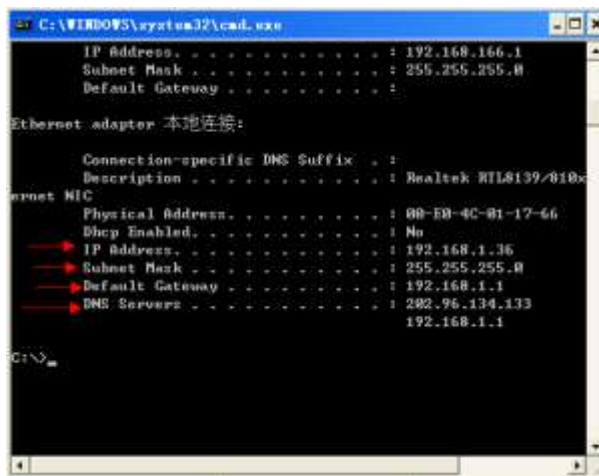

5. Take note of the following:

- IP Address
- Subnet Mask
- Default Gateway
- DNS Servers

6. Enter the details noted in step 5, and input relevant fields. IP address should be different.

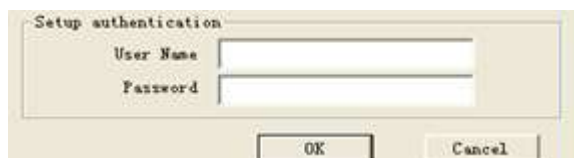

7. Input user and password, and click “ok”, the following screen will be displayed.

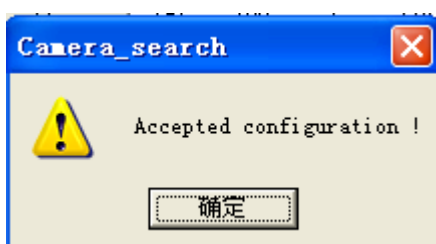

Click“OK” and finish.

---

# NETWORK CAMERA SCREEN AND SETUP WINDOW

## Review Images from the Network CAMERA

You can select one of the three ways to review pictures from the camera.

1. Input the assigned IP address (or URL) of the camera on the Web Browser., for example, 192.168.1.239. The below dialog will appear. Input the correct username (the default is admin, in lowercase) and password (the default is admin, in lowercase). Choose the language (the default is English),you are allowed to enter the picture viewing interface or the system setting interface.

The general users assigned by the administrator are not allowed to enter the system setting interface. They can only be permitted to enter the picture viewing interface.

2. Open “camera search” Tool and double-click the relevant camera item.

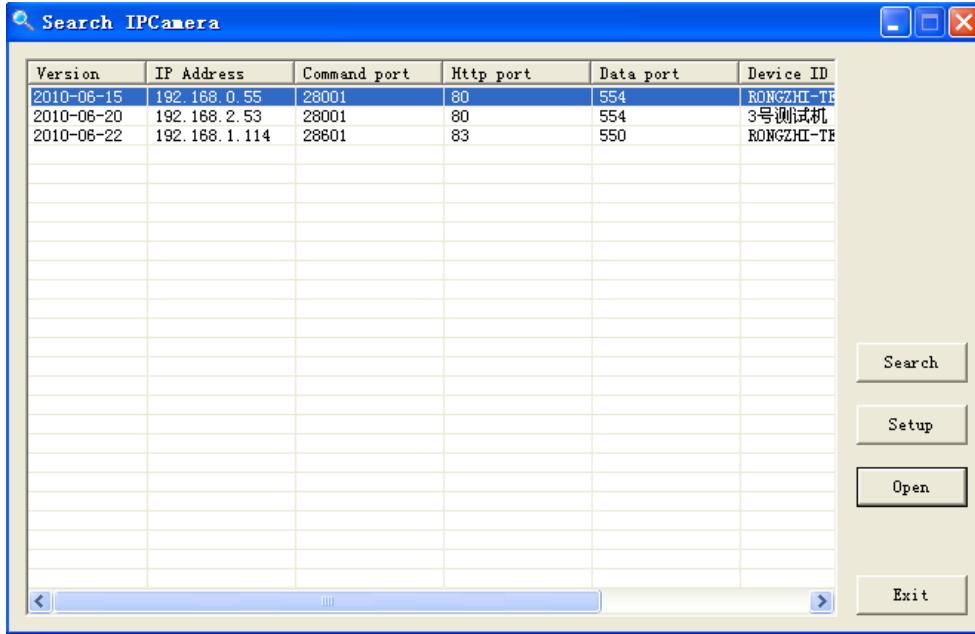

3. Run manage device in video client software.

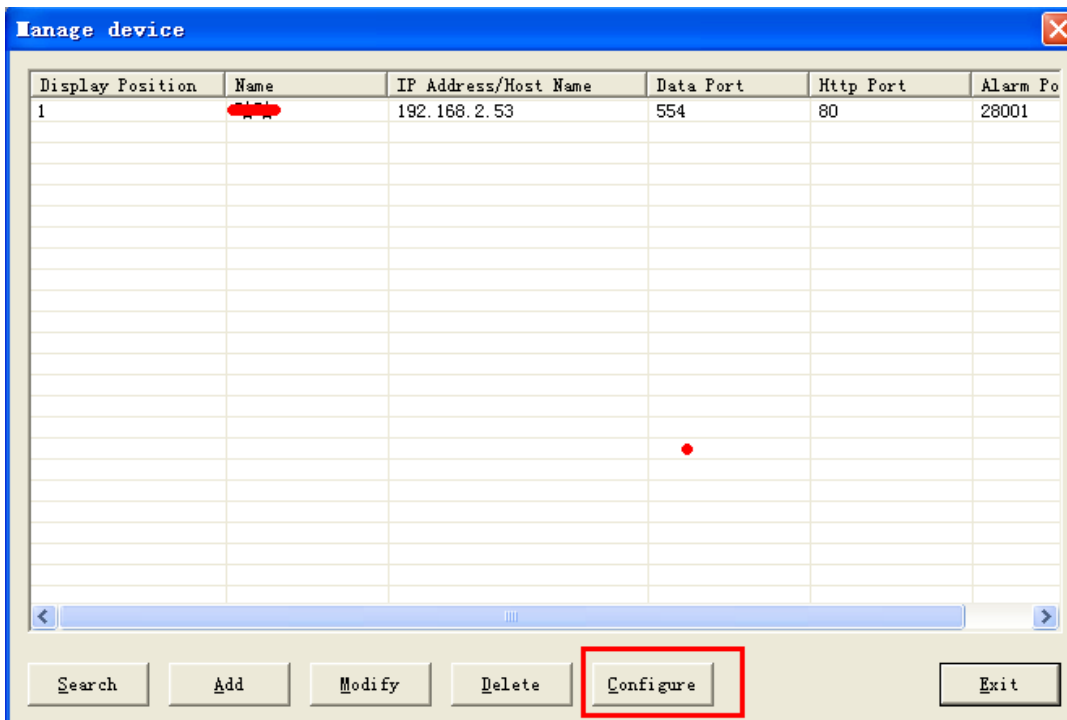

## Introduction of Main page

When access the network camera at the first time, IE will be prompted to install the ActiveX control. Users can install it with the following steps:

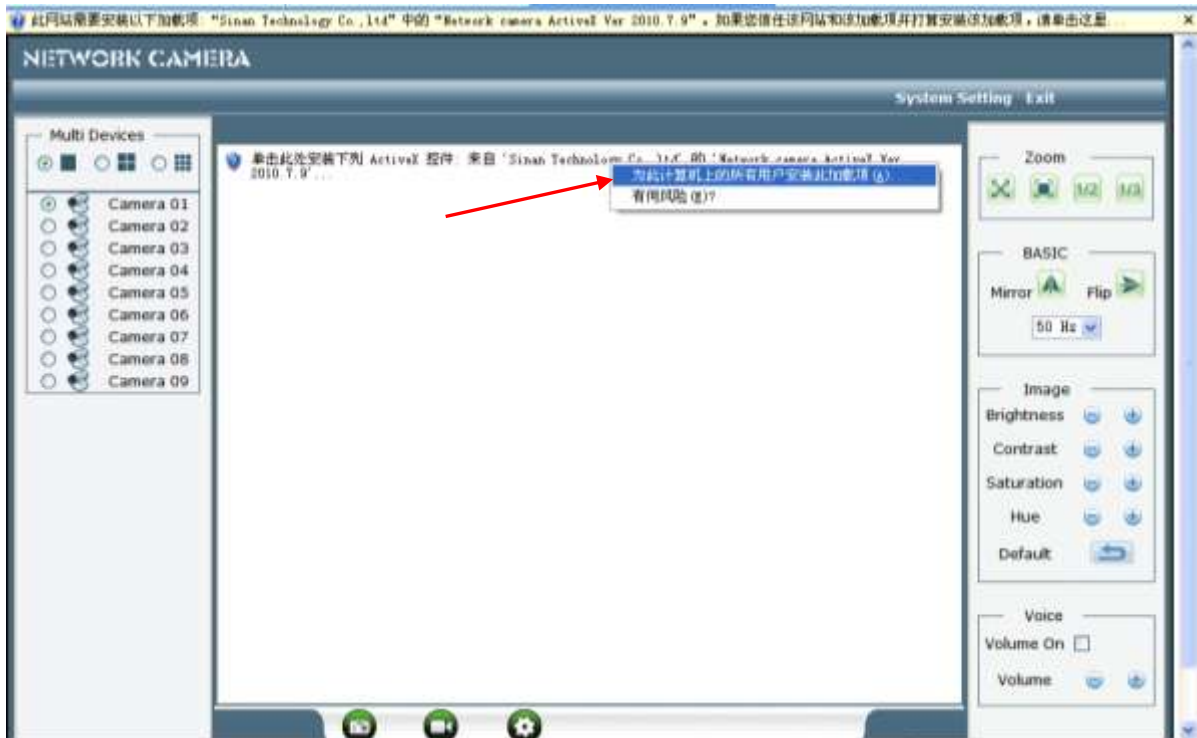

Click the highlight in blue, the following page will appear.

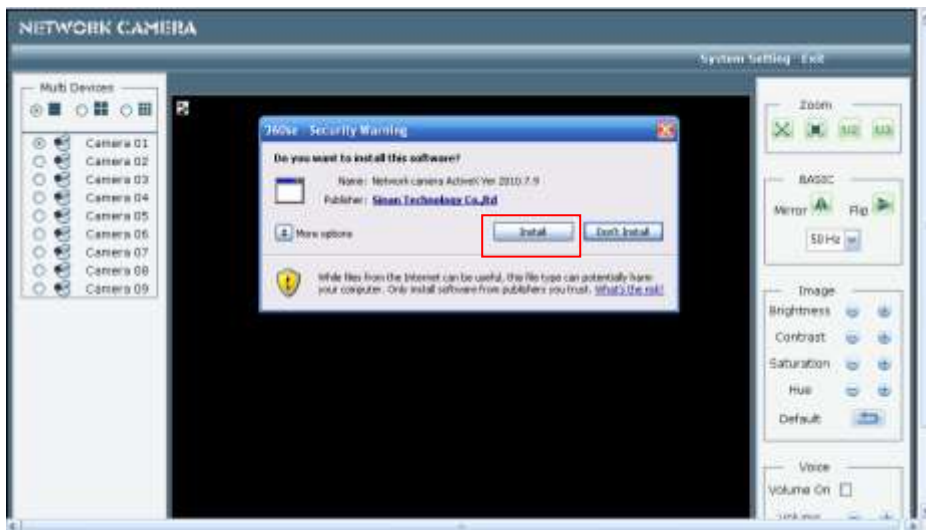

When you download and install the ActiveX control, refresh the page. You will then view the following screen in your web browser.





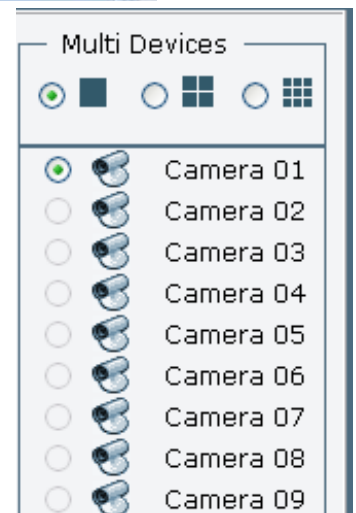

### 1. Multi Devices select

- First add device in system setting, “camera setting”—“multi channel setting”
- Select four channel or nine channel
- Choose one camera, and then capture, record and image setup.

### 2. Pan/Tilt control



### 3. Screen Size

-  :Full screen
-  : 640\*480
-  : 320\*240
-  160\*120



---

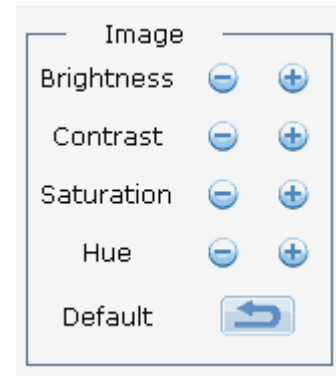

#### 4. Image Setting

You can adjust the Brightness, Contrast, Saturation and hues of the image, you also can restore to Default Image by Default button.





#### 5. Press the Record button.

a)  : snapshot

b)  : Click Record, the color of the button will change to 



6. The default is mute, and click "Audio" button to open the audio. Click on  button and  button to adjust the volume

## System Setting

From the home page click "System Setup" to start the "advanced function" setting. First you can see page of status.

## System status

**System**

Name:	IPCamera1
Time:	2010-7-15 23:59:27
Firmware Verison:	1.0.0.1
MAC Address:	00:e0:6c:56:80:38

**SD Card**

SD Card Status :	unmount
------------------	---------

**Ethernet**

NetMode:	DHCP
IP Address:	192.168.2.54
IP Mask:	255.255.255.0
Gate way:	192.168.2.1

**PPPOE**

PPPOE Status :	Dis able
----------------	----------

**DNS**

Primary DNS:	192.168.2.1
Secondary DNS:	

**Network Port**

HTTP Port :	80
RTSP Port :	554
Control Port :	28001

**DDNS**

DDNS:	Enable
Domain Name :	sample.3322.org
External IP Address :	

**UPNP**

UPNP Status :	Enable
External IP Address on Gate way :	113.110.255.134
Internet Address :	http://113.110.255.134:80

System status includes system information, such as version No, status of memory card, Ethernet address and so on.

## Network

### Local network

The camera is set up to obtain the IP address automatically (DHCP) by default. Should you may wish to assign the IP address manually, use the TCP/IP Setup page to enter the address details.

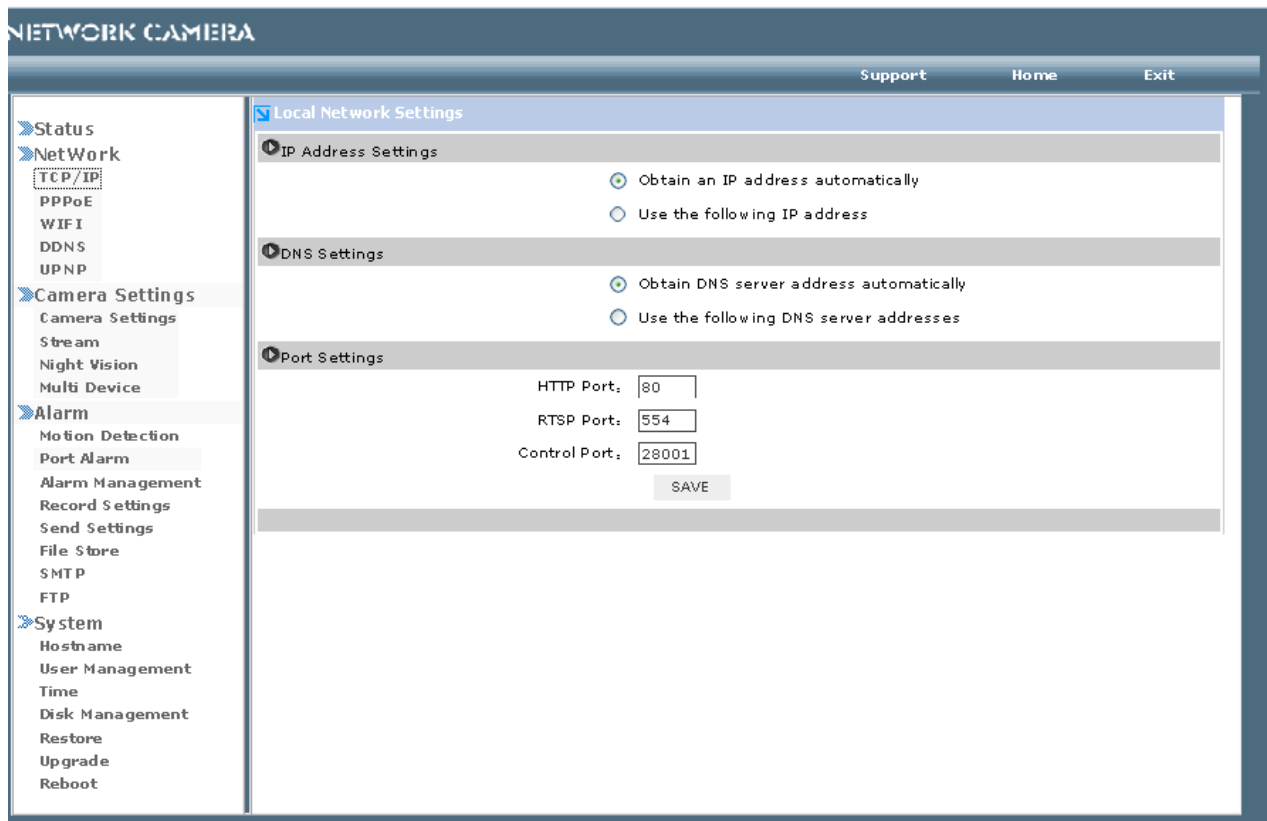

- “IP configure Mode”
  - Obtain an IP address automatically (DHCP):  
If your network supports a DHCP server (e.g. router) select this option to have the IP address is assigned automatically.  
If you select Obtain an IP address automatically you should select obtain a DNS Server address automatically.

Manual (Static) select this option when a fixed IP is required.

- If there are many cameras in LAN, we suggest that you select static IP address so that you can manage easily.  
**【IP Address】** Type the IP address of your camera.  
**【Subnet mask】** Type Subnet mask  
**【Default Gateway】** Type the default gateway.



**Notice:** To get IP address, you can refer to the information above or get help from your network administrator.

- **DNS Setting**
  - **Obtain DNS server address automatically**  
If your network supports a DHCP server (e.g. router) select this option to have the DNS Server address is assigned automatically.
  - **Manual set up DNS server addresses**  
Set up a preferred DNS and alternate DNS.
- **Port settings**

- **HTTP Port**

The default is 80.

- **RTSP Port**

The default is 554, used for video.

- **Control Port**

The default is 28001, offer control service, such as alarm, mirror, and image setting.

Any changes of this page will lead to system reboot. Making sure all parameters correct before clicking the “apply” button.



**Notice:** If you need enable UPNP function or relevant port in router through external camera, you can get help from your router manual or network administrator.

## PPPOE Account Configure

Camera can be installed without a PC on the network. Some ADSL server support PPPOE.

PPPOE Settings

PPPOE Settings----When PPPOE dial-up, you need to connect your modem.

PPPOE Dial UP:  Enable  Disable

Username:

Password:

Notify users when IP address changed:  FTP [FTP Settings](#)

SMTP [SMTP Settings](#)

### PPPOE settings

- **【PPPOE Dial up】** Enable or disable PPPoE connection.
- **【User name】** consult your local ISP provider.
- **【Password】** Input your password of ADSL
- Notify user when IP address changes:
  - 【FTP】** Enabled the option, send the obtained IP address to your FTP server when PPPOE is successful.
  - 【SMTP】** Enabled the option, send the obtained IP address to your email server when PPPOE is successful.

Click “save”, connect RJ45 XDSL cable to network interface of the camera and then reboot.

## Wireless Network

Wireless network card supports IEEE802.11b / g wireless standards

WLAN Settings

Wlan Device Scanning : Scanning

WLAN Enable : Disabled

SSID :

Wireless Mode : AP

Security : None

SAVE

- **Wireless access point scanning**
  - Search available wireless networks
- **Enable wireless network**
  - Enable and disable wireless card.
- **SSID**                    SSID (Service Set Identifier):
  - Manually type maximum 32 ACSII characters, can also choose wireless SSID searched.
- **Wireless mode**
  - Access point (infrastructure): Through the selection of access point or router.
  - Point to point: select when camera connection with the computer directly

WLAN Settings

Wlan Device Scanning : Scanning

WLAN Enable : Enable

SSID : Network Camera

Wireless Mode : AP

Security : WEP

Authentication : Auto

Key Type : 64 bits

Key Format : HEX

Key Length Description : You must input 10 HEX characters or 5 ASCII characters when you choose 64 bits key length. And input 26 HEX characters or 13 ASCII characters when you choose 128 bits key length.

Key : 8888888888

SAVE

- **Security Mode**
  - **WEP**
    - ◆ **Authentication: Select WEP Authentication mode**

- ◆ **WEP Key type:** WEP 64bits or WEP 128bits
- ◆ **WEP Key Index:** Select the WEP key type. Either in 16 hex or ACSII characters optional
- ◆ **WEP Key:** Type the password

## ■ WPA、WPA2

- ◆ **WPA Algorithms:** Select TKIP or AES
- ◆ **WPA KEY:** Type the password

Click “Apply”to save changes and finish.



**Notice:** These settings have to match those of your access point or router. Please consult your access point or router manual on how to verify or modify these settings.

## DDNS Settings

Dynamic DNS (DDNS) is simply a way of using a static hostname to connect to a dynamic IP address. When connect to your ISP, you are assigned a temporary IP address. DDNS services keep track of your IP address and route your Domain Name to that address when you wish to connect to the camera from a remote location.

### How to add and set up DDNS

- ◆ Enable the Dynamic DNS function
  - ◆ Click the Domain name server link, register domain name after account for it. ; If you already have a dynamic domain name, you can skip this step.
  - ◆ Select your preferred DDNS service provider from 3322.org or Dyndns.org then click register
  - ◆ Set the DDNS update time which is used to detect any changes of IP address, in order to submit updated information to the server in time.
  - ◆ Enter the Domain Name details supplied by your DDNS service provider
  - ◆ Enter the Host Name details and password supplied by your DDNS service provider when you registered
- Click “Apply” to confirm your settings.

## UPnP

The camera supports the UPnP functions outside the network, it can automatically port forwarding with your router, it is a quick way to access and discover your camera on the external network. Please make sure that the UPnP function is enabled on your PC and make sure your router support UPnP function.

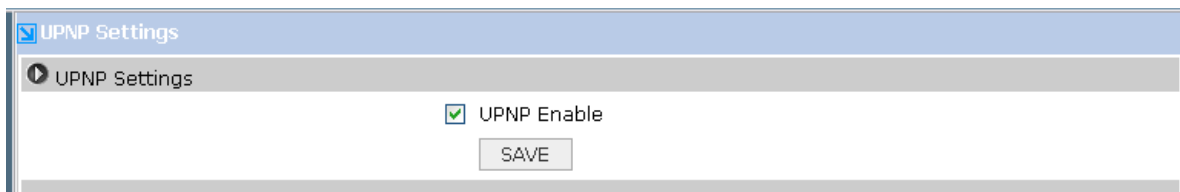

Enable UPnP port forwarding, and click “save”, you can see IP address in internet.



---

# Camera Settings

## Camera Settings

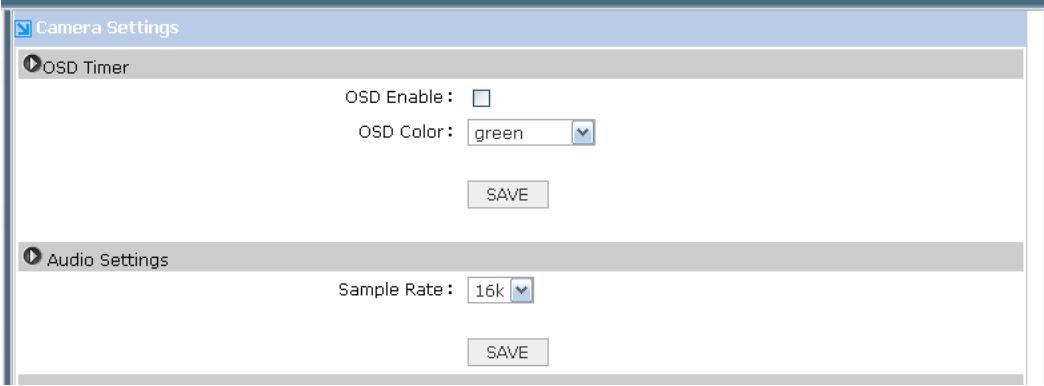

The screenshot shows a web-based settings interface for a camera. It has a blue header bar with the text "Camera Settings". Below the header, there are two main sections: "OSD Timer" and "Audio Settings".

The "OSD Timer" section contains the following controls:

- "OSD Enable": A checkbox that is currently unchecked.
- "OSD Color": A dropdown menu with "green" selected.
- A "SAVE" button.

The "Audio Settings" section contains the following controls:

- "Sample Rate": A dropdown menu with "16k" selected.
- A "SAVE" button.

- OSD Timer Settings
- OSD Enable: Display date and time
- OSD Color: Display color of information
- Audio Settings
- Sample Rate: Users can select 16, 24, 32, 48 kbps to determine the quality of the audio transmission

Click "save" and finish.

## Stream Setup

Network Camera

Stream List

RTSP Authentication:  ENABLE  DISALBE

Stream List

PC Stream

Bit Rate Mode  Quality Mode

Quality: Good

Bit Rate: 512 kbps

Resolution: 640x480

Frame Rate: 15 fps

Mobile Stream

MPEG4

You can choose MPEG4 if you want browse by Mobile Phone(3GPP); Or you can choose MJPEG if you want browse by Firefox.

Bit Rate Mode  Quality Mode

Quality: Detailed

Bit Rate: 32 kbps

Resolution: 160x120

Frame Rate: 5 fps

SAVE

- **RTSP Authentication:** Enable or disable RTSP stream authentication. You can use mobile phone to play the mobile stream from camera, but generally mobile phone do not support authentication, so we have to disable the RTSP authentication.
- **Stream List:** A stream list will be shown as below after clicking the stream name such as " PC stream"

Stream List

LAN Stream LIST	
RTSP MPEG4 PC Stream:	rtsp://192.168.2.54:554/stream
RTSP MPEG4 Mobile Stream:	rtsp://192.168.2.54:554/mobile

Internet Stream LIST	
RTSP MPEG4 PC Stream:	rtsp://113.110.255.134:554/stream
RTSP MPEG4 Mobile Stream:	rtsp://113.110.255.134:554/mobile

Close

You can use RealPlayer, VLC Player or Quick Time Player to play the live stream from camera in intranet or internet. You can also use mobile phone, Real player and quick time player to play the live stream from camera. The size of video is 176 X144.



**Notice:** You can adjust frame rate and image quality to get a good view results when you

access camera from internet.

## ● PC Stream Setup

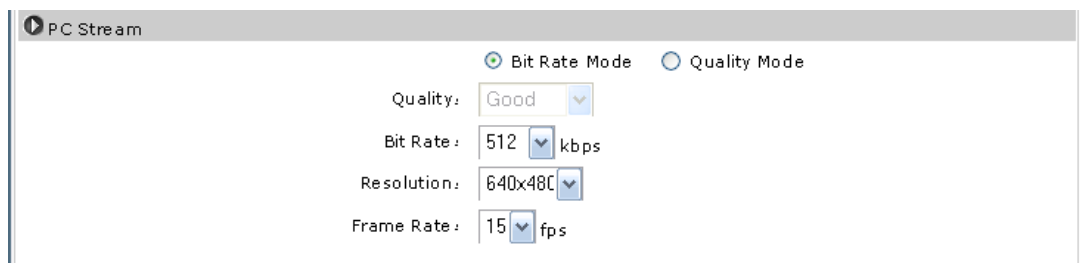

The screenshot shows the 'PC Stream' configuration window. At the top, there are two radio buttons: 'Bit Rate Mode' (selected) and 'Quality Mode'. Below this, there are four dropdown menus: 'Quality' set to 'Good', 'Bit Rate' set to '512 kbps', 'Resolution' set to '640x480', and 'Frame Rate' set to '15 fps'.

- Bit Rate Mode: Set a fixed data bit stream
- Quality Mode: Set up image quality below, and after selecting one, bit rate of date will adjust automatically.
- Quality: Medium、Standard、Good、Detailed、Excellent, Medium selected
- Bit Rate: Fourteen options: 64、128、192、256、320、384、448、512、576、640、704、768、1024、1536 (kbps)
- Image size: Three image resolutions available:640x480(VGA)、320x240(QVGA)、160x120.
- Frame rate: Five options: 5、10、15、20、25 frames per second (fps) .More higher, more clearer.

**Note: The above settings determine the image quality, however higher bit rates require greater bandwidth. Please select the appropriate settings according to your connect speed and network traffic. If you are experiencing jerky video it may be necessary to decrease the bit rate.**

## ● Mobile Stream

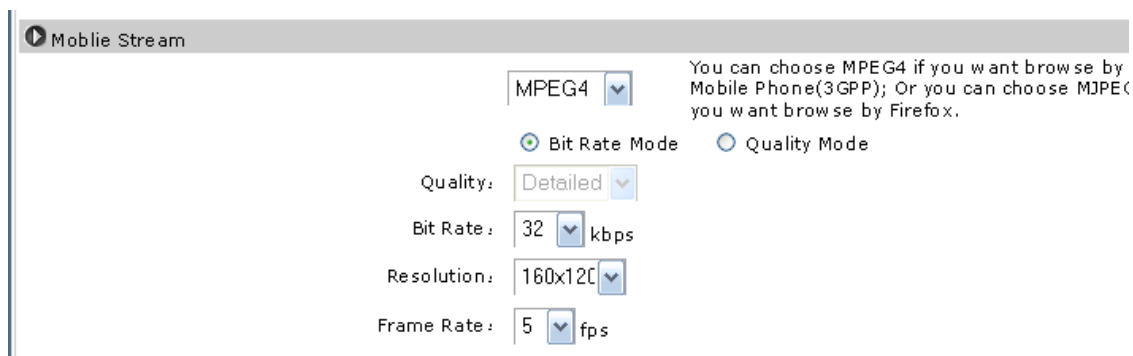

The screenshot shows the 'Mobile Stream' configuration window. At the top, there is a dropdown menu for 'MPEG4'. To its right, there is a note: 'You can choose MPEG4 if you want browse by Mobile Phone(3GPP); Or you can choose MJPE( you want browse by Firefox.' Below this, there are two radio buttons: 'Bit Rate Mode' (selected) and 'Quality Mode'. Below this, there are four dropdown menus: 'Quality' set to 'Detailed', 'Bit Rate' set to '32 kbps', 'Resolution' set to '160x120', and 'Frame Rate' set to '5 fps'.

The default is MJPEG, and disable, MJPEG and MPEG4 are optional. Such as I IPHONE interview, enter IP address or dynamic domain name directly to see the picture as below



## Night Vision Settings

Camera has infrared LED lights, which can be opened automatically when camera check dark environment.

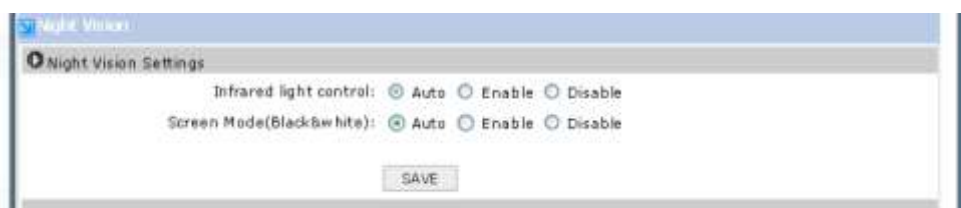

- **Infrared light control**

When the environment is dark, the LED will be opened automatically due to a photosensitive component. Users also can select open or close the infrared LED manually.

- **Black and white screen mode:**

When the environment is dark, the moving images will be changed to Black and White automatically. Users can also select whether change the images to black and white or color manually.

Click "Save" to confirm your settings

## Multi Device settings

Nine channels can be displayed simultaneously and be operated such as recording, snapshot and flip.

ID	Device Name	IP/Domain	RTSP Port	Control Port	Username	Password
<input checked="" type="checkbox"/> 1	IPCamera1	192.168.2.54	554	5551	admin	www
<input type="checkbox"/> 2						
<input type="checkbox"/> 3						
<input type="checkbox"/> 4						
<input type="checkbox"/> 5						
<input type="checkbox"/> 6						
<input type="checkbox"/> 7						
<input type="checkbox"/> 8						
<input type="checkbox"/> 9						

SAVE

- Choose relevant device.
- Device name: Give the name for identifying.
- IP address/Domain name: for the camera selected
- RTSP Port: for the camera selected
- Control port: for the camera selected
- User and password: for the camera selected

## Alarm Settings

### Motion Detection settings

If you need to use the alarm function via email, FTP server or SD card, please click the link of Alarm Configuration, FTP Mail or Recorder setting. Also there are three motion detection areas, area 1, area 2 and area 3 , you can choose three Areas at the same time.



- Window: Three windows can be set up. And the area of the window can be changed and adjusted.
  - Threshold: Control probability of alarm. MAX: Left; MIN: Right.
  - Sensitivity: Identify the sensitivity of change. MAX: Right; MIN: Left
- After finishing the setup above, please click “Apply”.

### Port Alarm

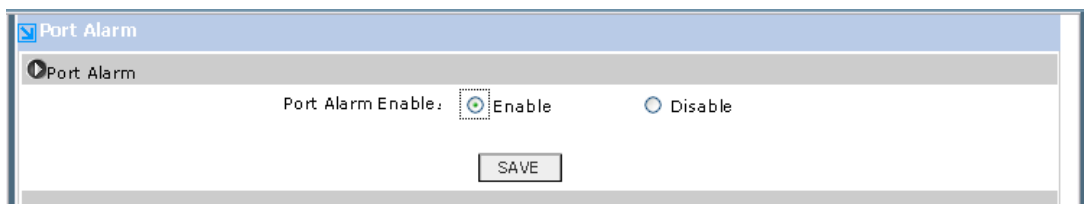

This page enables I/O alarm port.

To implement I/O alarm please check to enable and configure the inspection interval at the same

time to check linkage to the output ports in alarm

Description of back of the device: Input ①② Output ③④



## Alarm Management



- Alarm Enable: Enable or disable alarm function
- DO: Motion detection is transported to external alarm device, such as alarm light, alarm whistle
- Record into SD card: Alarm of motion detection is recorded into SD card. Also images can be sent to FTP server and Email server
- Recording time: Set up the length of record.
- Snapshot: It means to capture images. The images can be sent to FTP server and Email server if the two options are selected.
- FTP Alarm: Images are sent to FTP server. Click “FTP SETTINGS” to set up.

Refer to the following **FTP Setting**

- Mail Alarm: Images are sent to email. Click “SMTP SETTINGS” to set up.

Refer to the following **SMTP Setting**

- Valid time: Set up alarm period. “Always” or “AS Table” selected.
- Alarm table settings: Click “AS Table” to set up.

- **【Every day】** Select or not
- **【Sunday - Saturday】** Select or not
- **【All】** Open all the time
- **【Between】** open in the time range selected
- **【Beyond】** open out of the time range selected

Click “save” and all finished.

**Schedule (alarm)**

Everyday    Between    Begin 08 : 00    End 17 : 00

SUN    Between    Begin 08 : 00    End 17 : 00

MON    Between    Begin 08 : 00    End 17 : 00

TUE    Between    Begin 08 : 00    End 17 : 00

WED    Between    Begin 08 : 00    End 17 : 00

THU    Between    Begin 08 : 00    End 17 : 00

FRI    Between    Begin 08 : 00    End 17 : 00

SAT    Between    Begin 08 : 00    End 17 : 00

### Periodic Record Schedule

Network camera can record the images or videos periodically.

**Periodic Record Schedule**

Enable     Disable

Store Location:  SD Card

Store Size: 99 MB

Valid Time:

- Store Size: set up the size of store files. MAX 99MB
- Valid Time: set up schedule

### Periodic sending

Network camera can sent images periodically through FTP.

**Periodic Send Settings**

**FTP Send**     Enable     Disable

Interval Time: 0 hour 0 minute 10 second 0 mil-second  
(Min: 200 mil-second , Max: 24 hour)

Valid Time:  Always     As Table   

- Intervals time: set up the interval time
- Valid Time: Set up the schedule  
Click "save" and all finished.

### File Store

Operate (download or delete) the files in SD card.

Support Home Exit

File

Select

File Type  Picture  Record

Time

Begin 2010 year 7 month 16 day 1 hour 6 min

End 2010 year 7 month 16 day 1 hour 6 min

Search

- File type: Select file types will be searched
- Time: Set the start time and end time.
- Click “search”, and the pictures or videos list will be displayed as following.

NETWORK CAMERA

Support Home Exit

File List

File	Record Time	Size(Byte)	Operation
record-video-2010-07-07-20-30-14.avi	2010-07-07 20:30:14	2866150	<a href="#">Download</a> <a href="#">Delete</a>
alarm-video-2010-07-07-20-30-43.avi	2010-07-07 20:30:43	1047746	<a href="#">Download</a> <a href="#">Delete</a>
record-video-2010-07-07-20-30-54.avi	2010-07-07 20:30:54	93960	<a href="#">Download</a> <a href="#">Delete</a>
alarm-video-2010-07-07-20-30-55.avi	2010-07-07 20:30:55	1092888	<a href="#">Download</a> <a href="#">Delete</a>
record-video-2010-07-07-20-31-06.avi	2010-07-07 20:31:06	109002	<a href="#">Download</a> <a href="#">Delete</a>
alarm-video-2010-07-07-20-31-07.avi	2010-07-07 20:31:07	1104566	<a href="#">Download</a> <a href="#">Delete</a>
record-video-2010-07-07-20-31-18.avi	2010-07-07 20:31:18	248322	<a href="#">Download</a> <a href="#">Delete</a>
alarm-video-2010-07-07-20-31-20.avi	2010-07-07 20:31:20	1062968	<a href="#">Download</a> <a href="#">Delete</a>
record-video-2010-07-07-20-31-31.avi	2010-07-07 20:31:31	603960	<a href="#">Download</a> <a href="#">Delete</a>
alarm-video-2010-07-07-20-31-37.avi	2010-07-07 20:31:37	1105876	<a href="#">Download</a> <a href="#">Delete</a>

Return Previous Next

- Click “download”, save as local computer
- Click “delete”, delete the files in SD card
- Click “back”, back to store settings.
- Previous and Next: Page turns.

## SMTP

Set up the sending server and receiver server.

- SMTP Server Number: choose one mail server from the four options in the list.
- SMTP Server: Enable or Disable
- Email Subject: Title of the email about alarm
- Recipient: email address of receiver. Three selected
- Sender: email address of sender.
- SMTP Server: name or IP of server. Please get details from SMTP server or network administrator.
- SMTP Port: The default is 25.
- User and password: Input the user and password of your email.

## FTP

Set up files server for alarm pictures and recordings.

- **FTP Server Number:** Choose a FTP server from the four options in the list.
- **FTP Server:** Enable or disable
- **FTP Server Address:** Address or IP of FTP server. Please get details from network administrator.
- **FTP Port:** The default is 21.
- User and password: Input the user and password of your FTP server.
- **PASV Mode:** Enable or disable

When finishing the setting above, please click “save”.



- Input the user name
  - Select the appropriate permissions in the user group, Three selected.
  - Guest: see live video
  - Operator: manage settings in system
  - Administrator: the top authentication. Notice: admin can't be deleted
  - Input "User Name" and "Password"
  - Add the new user
- **Delete User Account**

Select the account which be deleted.



**Notice:** The default admin can't be deleted

- **Modify account password**

Select username to modify, and then input old password and new password twice. Click **"MODIFY"** and finish.

## Time Settings

- System Time: current time in camera
- Synchronize with PC: current time in computer
- Custom Input: Input time by yourself

- Time Zone Settings: select the time zone
- NTP Settings:
  - ◆ Enable
  - ◆ NTP server: Input NTP time server
  - ◆ NTP synchronization: Select NTP synchronization period
  - ◆ Click “save” and finish

## Disk Management

### Disk Management

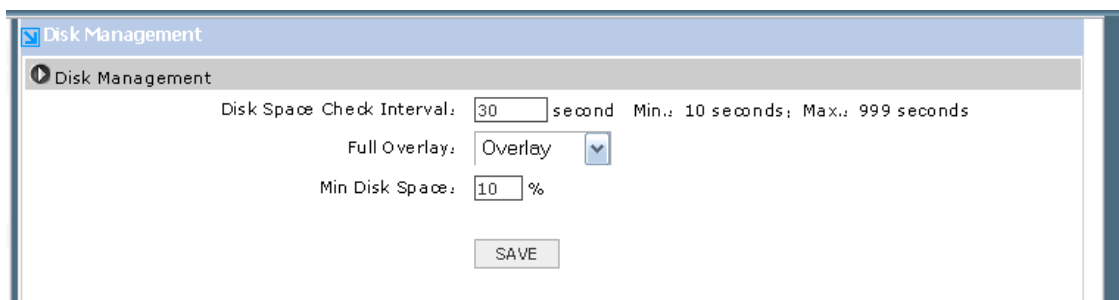

- Disk Space Check Interval: Set up disk space check interval
- Full Overlay: Overlay or not, when there is least space left.

- **Format TF card**

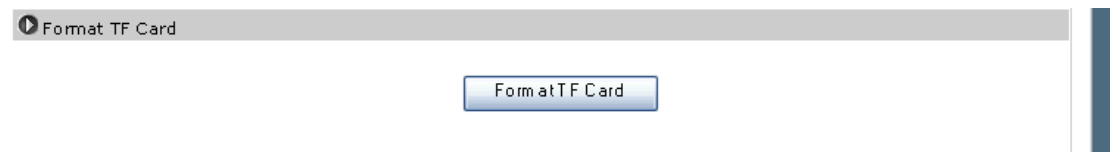

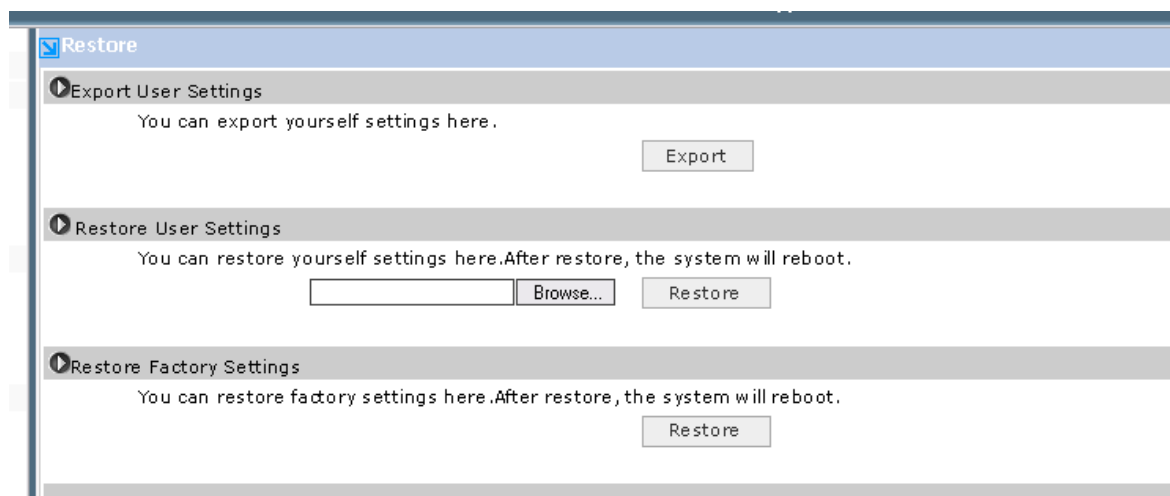

**Notice:** click “format TF card”, and delete all the files in TF card. Be careful!

## Restore



- **Export User Settings:** Click “Export”, and export current settings to save
- **Restore User Settings:** Click “browse”, and select a back up files, and then Click “Restore” to finish.
- **Restore Factory Settings**

 **Notice:** You can't turn off the electronic power while restoring user settings and restore factory settings, otherwise, the camera will be damaged.

 **Tips:** “Reset” in camera body

1. Press “Reset” to reboot
2. Press “Reset”, and provide power about 15 –t 30 seconds. Restore factory settings.

## Firmware Update

You can update the camera with newest firmware which is modifying the bug in the old firmware or add some new functions.

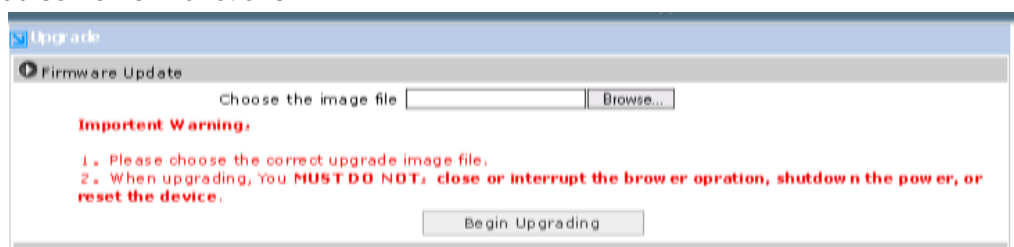

- Click “Browse”, select the latest firmware.
- Click “Update”
- Finish and reboot.

 **Notice:** You can't turn off the electronic power while updating, otherwise, camera can't work correctly.

# High Speed Dome IP Camera

Specification	Model	SD3680 (High Speed Dome)
Camera	Image sensor	1/4 CCD 480 TVL
	Lens	220x Zoom
	Pixel	410,000
	Zoom (variable focus)	3.25-74.75mm, Speed is automatically matched against PTZ function(Ratio Zoom Function)
	Infrared LED	no
	Night vision Distance	no
	AWS/AGC/AES/ exposure	auto
	Compression	MPEG-4&MJPEG dual compression
	Stream type	HTTP;RTSP;RTP;RTCP;3GPP;MP4
	Max. frame rate	30FPS@NTSC 25FPS@PAL
	Resolution	PAL:176x144;352x288;720x576 NTSC:176x120;352x240;720x480
	Horizontal view angle	360 °Continuous Rotation
	Vertical view angle	90 °, 180° auto rotation no blind area
PTZ	Preset position	16
	Level speed	0.5°-240°/S
	Vertical speed	0.5°-240°/S
	PTZ baud rate	2400,4800,9600 for optional, PTZ protocol PELCO P/D
Network	Network interface	RJ-45 (10BASE-T/100BASE-TX)
	Protocol	TCP/UDP/IP/ARP/ICMP/DHCP/DNS/HTTP/FTP/SMTP/NTP/PPPoE/UPnP/DDNS/RTSP/RTP/RTCP
Alarm	Motion detection	Three configurable zones for schedule motion detection
	Alarm events	<ul style="list-style-type: none"> <li>• Notification via email, FTP</li> <li>• External output activation and input devices alarm</li> <li>• Video recording to local storage</li> </ul>
	periodic sending	Send image pictures to Email/FTP within the Provides time
General	User Authentication	Authentication: user /password; administrator/general user
	Simultaneous viewer	10 viewers @352x240 4 viewers @720x480
	Web browser	IE 6.0 or above version, Mozilla Firefox, Safari, Opera, Chrome ,etc
	Supported mobile	Nokia ,Iphone ,window mobile and other smart phone
	Power	DC 12 V 4A
	Power consumption	4W /6W (Infrared on/off)
	Operating temperature	-5 to +45 °C (+22 to +113 °F)
	Storage temperature	-20 to +60 °C (-4 to +140 °F)
	Operating humidity	20 - 80%RH
	Storage humidity	20 - 95%RH
	Dimensions	156m(L)x 240mm(W)x273mm(H)
Net Weight	6.7KG	

## Mid Speed Dome IP Camera

Specification	Model	SD3722 (Mid Speed Dome)
camera	Image sensor	1/4 CCD 480 TVL; 1/4 CCD 420 TVL
	Lens	30x Zoom
	Infrared LED	Change the LED light according to the focal distance of camera
	Pixel	410,000
	Night vision distance	100M
	AWS/AGC/AES/Exposure	AE
	Chip card	SONY/LG
Video parameters	Image format	PAL/NTSC
	Compression	MPEG-4&MJP EG dual compression
	Stream type	HTTP;RSTP;RTCP;3GPP;MP4
	Max. frame rate	30FPS@NTSC 25FPS@PAL
	Resolution	PAL:176x144;252x288;720x576 NTSC:156x120;352x240;720x480
	Horizontal view angle	360 °Continuous Rotation
	Vertical view angle	0-90 °
PTZ	Auto flip	Two class control(level control: horizontal: 180°, secondary control vertical:90°)
	Preset position	128
	Level speed	0.1°-50°/S(1-64 optional) adjust
	Vertical speed	0.1°-30°/S(1-64 optional) adjust
	Time of controlling preset position	1-30S adjustable
Network	Network interface	RJ-45(10BASE-T/100BASE-XT)
	Protocol	TCP/UDP/IP/ARP/ICMP/DHCP/DNS/HTTP/FTP/SMTP /NTP/PPPoE/UPnP/DDNS/RTSP/RTP/RTCP
Alarm	Motion detection	Three configurable zones for schedule motion detection
	Alarm events	<ul style="list-style-type: none"> <li>• Notification via email, FTP</li> <li>• External output activation and input devices alarm</li> <li>• Video recording to local storage</li> </ul>
	periodic sending	Send image pictures to Email/FTP within the Provides time
General	User Authentication	Authentication: user /password; administrator/general user
	Simultaneous viewer	10 viewers@352x240 4 viewers@720x480
	Web browser	IE 6.0 or above version, Mozilla Firefox, Safari, Opera, Chrome ,etc
	Supported mobile	Support Symbian; windows Mobile; Iphone ect
	Power	DC 12V±0.5V
	Power consumption	15W
	Operating temperature	-20°-60°
	Storage temperature	-30°-70°
	Operating humidity	20-95%RH
Net Weight	5.67 KG	